

The factory sofa modular

by Ramón Esteve

The Factory Collection, designed by Ramon Esteve for Vondom, is **characterized by the aluminum profile and the “deployé” mesh**. Discover this collection of aluminium furniture composed of a modular sofa, an armchair, a lounge, a side table, a lamp, a coffee table, a high table, chairs, and a room divider.



Info

Description

Made from aluminum and with a very comfortable padding. Our fabrics are available in a wide range of colours and very pleasant to touch. This collection is suitable for an indoor and an outdoor use.

Modules

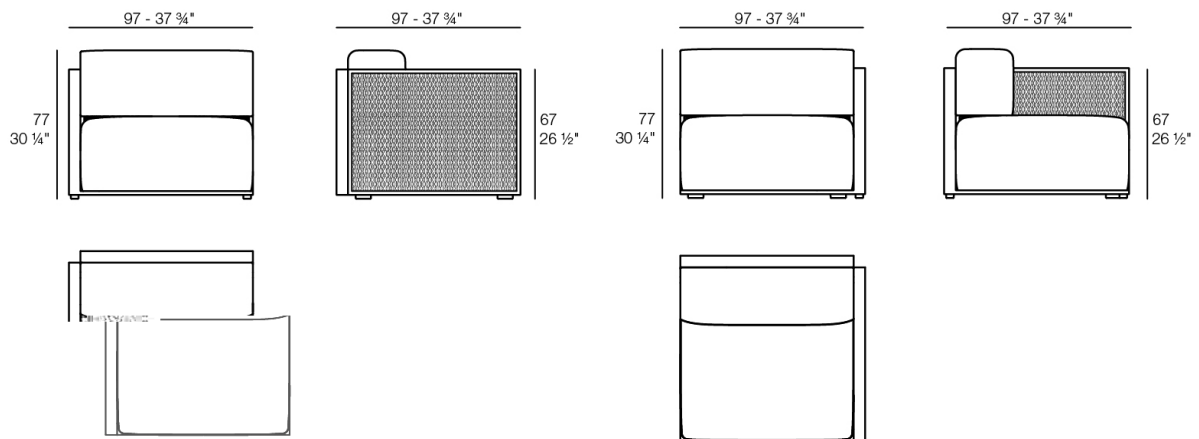

THE FACTORY Sofá Módulo Derecho
THE FACTORY Sectional Sofa Right

THE FACTORY Sofá Módulo Izquierdo
THE FACTORY Sectional Sofa Left

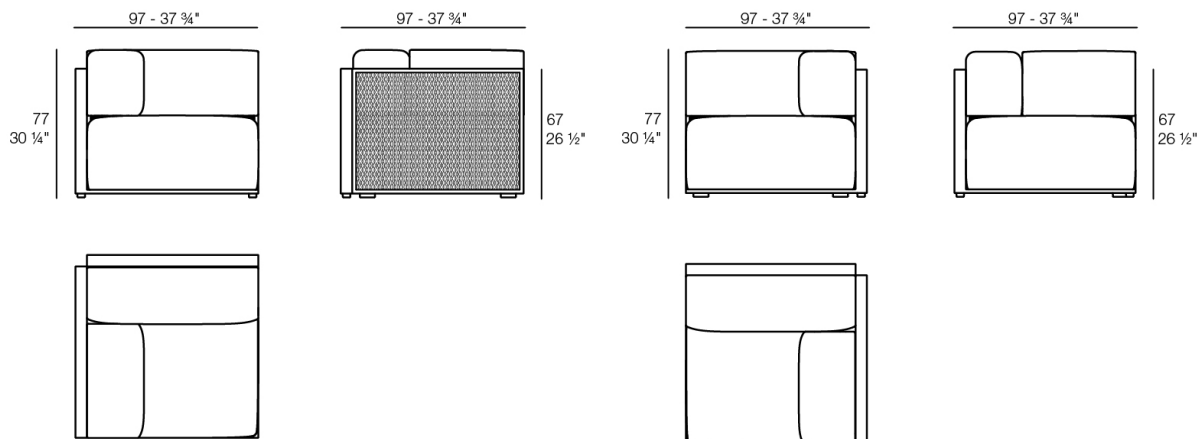

THE FACTORY Sofá Módulo Esquina Derecha
THE FACTORY Sectional Sofa Corner Right

THE FACTORY Sofá Módulo Esquina Izquierda
THE FACTORY Sectional Sofa Corner Left

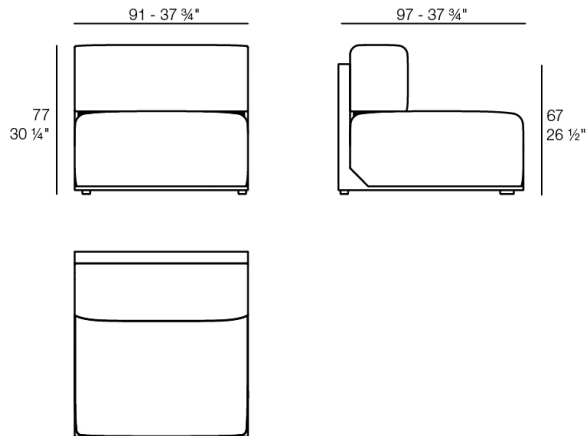

THE FACTORY Sofá Módulo Central
THE FACTORY Sectional Sofa Central

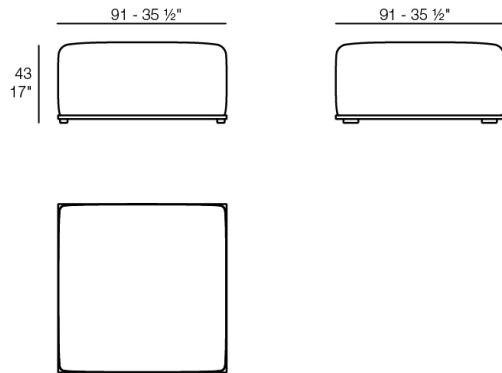

THE FACTORY Sofá Módulo Puff M
THE FACTORY Sectional Sofa Puff M

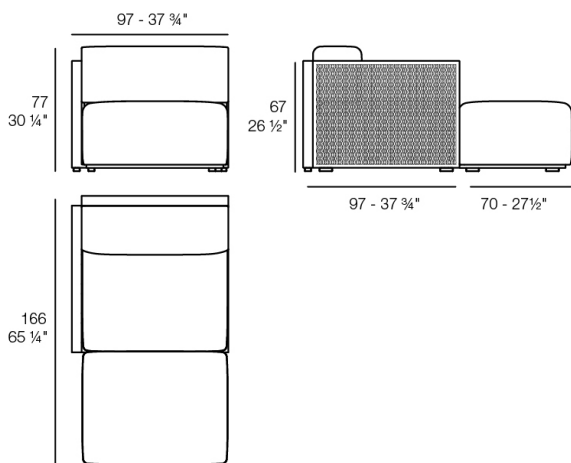

THE FACTORY Sofá Módulo Chaiselongue Derecho
THE FACTORY Sectional Sofa Right Chaiselongue

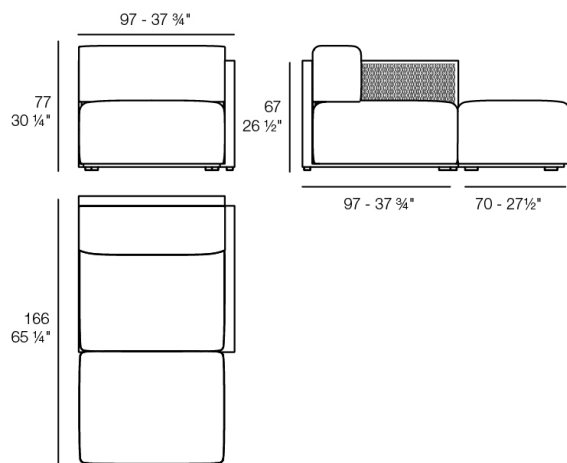

THE FACTORY Sofá Módulo Chaiselongue Izquierdo
THE FACTORY Sectional Sofa Left Chaiselongue

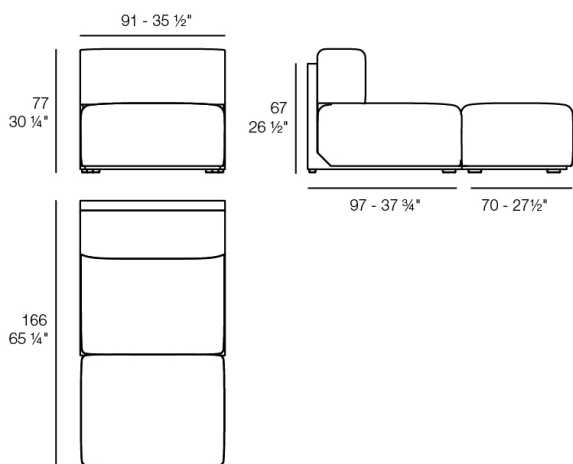

THE FACTORY Sofá Módulo Chaiselongue Central
THE FACTORY Sectional Sofa Central Chaiselongue

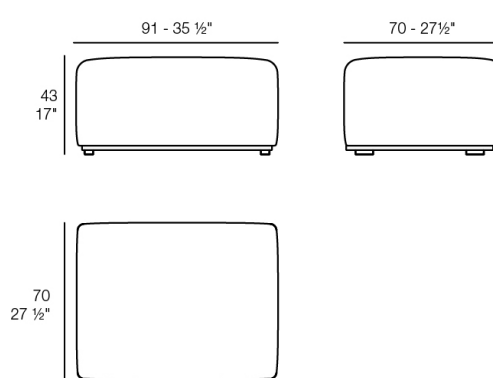

THE FACTORY Puff S
THE FACTORY Puff S

Finishes

aluminium

ALUMINIUM



white



british gray



traffic gray



black



ecru



crema



castoro fiber



cacao



notte blue



modo green

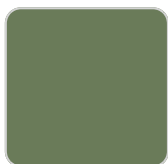

pickle

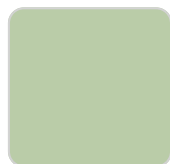

almond



red

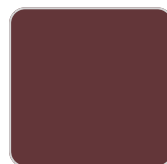

purjai red

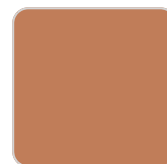

melon

Lacquered aluminium profile.

fabric

GLAD

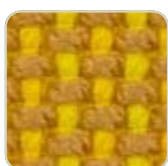

oro 1031



ocre 1051



sunset 1020



delhi 1038

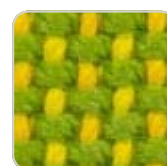

lima 1030

VONDOM



aguate 1028

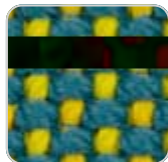

caribe 1004



bosc 1029



artemisa 1027



oasis 1007



oceano 1005



pruna 1045



noa 1026



berry 1021



amatista 1011

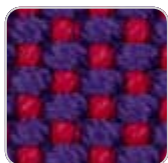

vera 1019



afrodita 1013



grana 1046



bacco 1034



dahlia 1035



wine 1012



foc 1052



hestia 1014



turquoise 1053

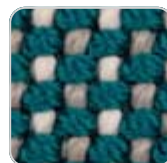

niord 1015



masai 1018



ultramar 1002



aquamarina 1003



esmeralda 1016

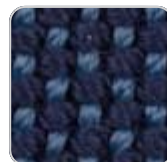

night 1024



galan 1025



eclipse 1023

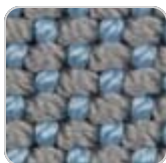

perla 1006



calipso 1017



snow 1041

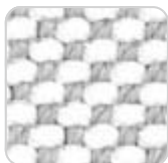

iceberg 1037

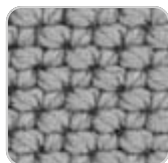

steel 1042



moon 1040



granito 1008



grey 1043



anthracite 1044



ecru 1047



dessert 1033



taupe 1048



terra 1039

VONDOM



duna 1009



moka 1010



chocolate 1050

Soft and cozy fabric suitable for indoor and outdoor use.

VARM

Soft and cozy fabric suitable for indoor and outdoor use.

HYGGE

Soft and cozy fabric suitable for indoor and outdoor use.

NAUTIC



bronze 1104

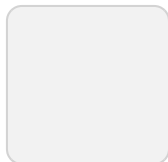

white 1100



crema 1103



red 1108



steel 1101



purjai red 1106



black 1105



orange 1113

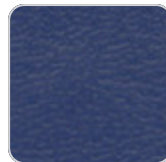

notte blue 1114



orange 3115

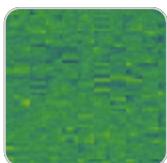

forest 1112

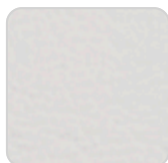

natural 1111

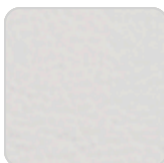

taupe 1102

Soft leather like fabric suitable for indoor and outdoor use. Standard option for

VONDOM

upholstery.

SILVERTEX



forest 1224



beige 1211



bronze 1214



khaki 1218



steel 1208



plum 2016



navy 3068



taupe 1209

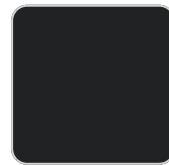

antrachite 1210

Vinyl fabric suitable for indoor and outdoor use. Special option for upholstery.

CREVIN



white 1308



steel 1309



taupe 1310



anthracite 1311

Upholstery fabric, that as and natural appearance and can be easy cleaned by washing machines, allowing an easy removal of mildew. Suitable for indoor and outdoor use

CICO

Cozy fabric with an elegant look and soft touch.

ACAPULCO

VONDOM

Cozy fabric with an elegant look and soft touch.

SIESTA

Cozy fabric with an elegant look and soft touch.

IKON

Cozy fabric with an elegant look and soft touch.

KROLLET

Soft and cozy fabric suitable for indoor and outdoor use.

HERITAGE



granite 1531

Outdoor fabrics are waterproof 50% recycled acrylic, 47% acrylic and 3% PE.

SAVANE



white 1501

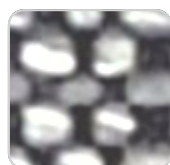

tornado 1503



whisper 1502

VONDOM

Outdoor fabrics are waterproof 100% acrylic.

Ambients

